

Cycle

In addition to our standard range we can produce signs to your specification, including advanced directional signs, enhanced visibility signs and street nameplates. All our signs comply to BSEN12899-1 2001 and are available with Class Ref 2 or Class Ref 1 reflective faces. Please contact our sales office for further details.



TR104
TR104C
450 diameter



TR129 450 dia.
TR129C 450 dia.
TR129A 600 dia.
TR129AC 600 dia.



TR130
TR130C
600 dia.



TR132C
384 x 430



TR133C
415 x 230



TR134C
440 x 300



TR137C
825 x 375



TR138AC
700 x 430



TR139C 580 x 550
TR139LC (handed left)



TR140C
700 x 430



TR141C
700 x 430



TR142C
700 x 510

Temporary Traffic



BS873 Class 2 reflective Temporary Traffic signs. Manufactured from 1mm reflective aluminium. Available with or without stanchion frames.



ZT1 600 x 450



ZT2 600 x 450



ZT3 600 x 450



ZT4 600 x 450



ZT5 600 x 450



ZT6 600 x 450



ZT7 600 x 450



ZT8 600 x 450



ZT9 600 x 450



ZT10 600 tri.



ZT11 600 tri.



ZT12 600 tri.
Can be shown with road narrowing to left or right both ways please specify when ordering.

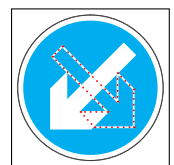

ZT15 600 x 600
ZT16 600 x 600
Handed



ZT13 600 x 450



ZT14 600 x 450



ZT35 600 x 450



ZT36 600 x 450



ZT37 600 x 450



ZT38 600 x 450



ZT39 600 x 450

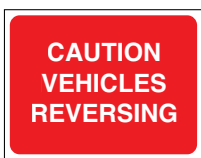

ZT40 600 x 450



ZT41 600 x 450



ZT42 600 x 450



ZT43 600 x 450

Street Signs

A selection of our most popular standard signs, all produced on 3mm aluminium. Available in either plate only for wall fixing or complete with two rows of channel for post mounting.



NW1 300 x 400
NW1C 300 x 400
(with channel)



NW2 300 x 400
NW2C 300 x 400
(with channel)



NW3 300 x 400
NW3C 300 x 400
(with channel)



WA100E 450 dia
WA100EC 450 dia
(with channel)



WA240 600 x 450
WA240C 600 x 450
(with channel)



PR158 600 x 450
PR158C 600 x 450
(with channel)



PR160 600 x 450
PR160C 600 x 450
(with channel)



TR149 450 x 600
TR149C 450 x 600
(with channel)



TR60A 320 x 250
TR60AC 320 x 250
(with channel)



TR188 600 x 450
TR188C 600 x 450
(with channel)



TR189 600 x 450
TR189C 600 x 450
(with channel)



TR186 600 x 450
TR186C 600 x 450
(with channel)

Cantilever Signs

Temporary Traffic Signs

We can manufacture these double-sided cantilever signs to your own requirements, supplying fittings to suit any diameter posts.

They can be produced using standard print, self adhesive vinyl or Class Ref 1 and 2 Reflective.

Please contact our Sales Office for further information.

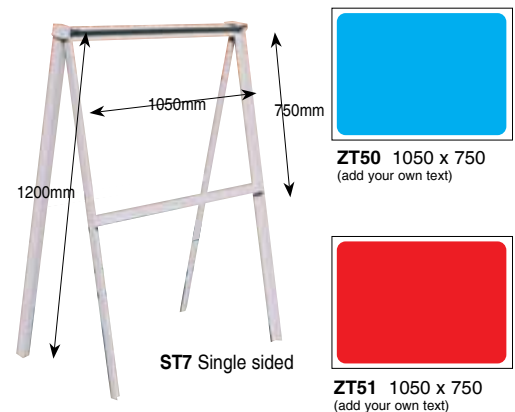

Road Traffic Blanks

Use these blank traffic signs to enforce your own personal site management policies. Available on 3mm aluminium with or without channel. For post fixing see page 104.

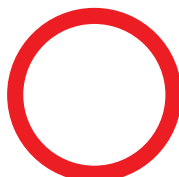

BTS1 600 dia.



BTS2 600 x 400



ZT17 600 x 450
(add your own text)



ZT18 600 tri.
(add your own symbol)



BTS3 600 high

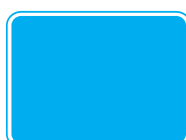

BTS4 600 x 450



BTS5 600 x 450

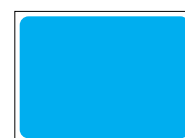

ZT44 600 x 450
(add your own text)

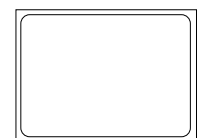

ZT45 600 x 450
(add your own text)

Available in 1mm reflective aluminium.

Posts and Fixings



Choosing the right fixing method is all important when choosing your signage requirements. From post mounted, to projecting signs or surface fixed to frame surround each option adds a different dimension to the finished scheme. Using the latest fabrication technology all types of fixing solutions can be undertaken to meet your exact requirements.

CAP1
Endcaps add a finishing touch to posts supplied separately.

POST1
1.5 metre
Traffic Post x 76mm
Grey, plastic coated steel for ultimate durability and good looks
Both heights supplied in 76mm diameter.

POST2
3 metre
Traffic Post x 76mm
Recommended depth of 400mm to be sunk into ground for POST1 or 600mm for POST 2.

BASE P1
Base plates for use in conjunction with traffic posts supplied separately.

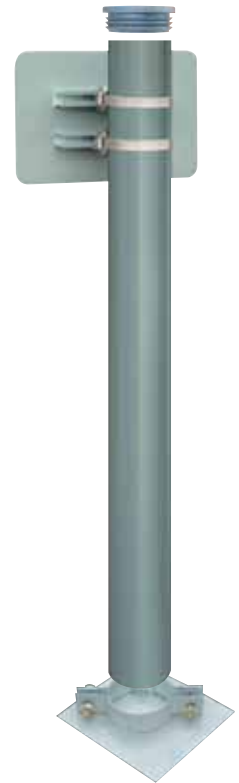

Standard Post Clips 50mm



CLIPS1
2" clips supplied in pairs. Suitable for scaffold poles or existing railings and barriers.

Back to back clips



CLIPS2
Used in conjunction with 76mm posts when connecting two signs back to back.

Standard Post Clips 76mm



CLIPS3
3" clips supplied in pairs. Suitable for scaffold poles or existing railings and barriers.



CA1
Channel Adaptors supplied in pairs Allow sign to be fixed to any post / railing regardless of diameter, used in conjunction with steel banding.



BB1 Banding buckles per 100.
BB2 Banding tool.
Ensures a permanent fix for steel banding. Buckles are supplied in boxes of 100. The banding tool is used for fixing signs in conjunction with channel adaptors and banding.



BB3
100' x 13mm roll steel banding for use in conjunction with channel adaptor will accommodate any non standard support.



STRAP1 (pair)
STRAP2 (pack of 10)
Steel buckle straps will strap onto posts up to 150mm diameter. Easy tighten operation ideal when a full roll of banding is not required.



STRAP4 (600mm)
Screw banding will strap to oversized posts and tightens using a screw driver. Sold in pairs

Stanchions

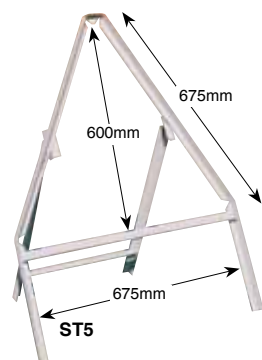
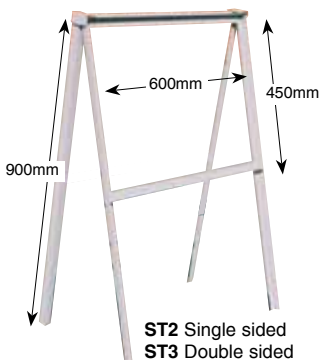

Rubber Speed Ramps

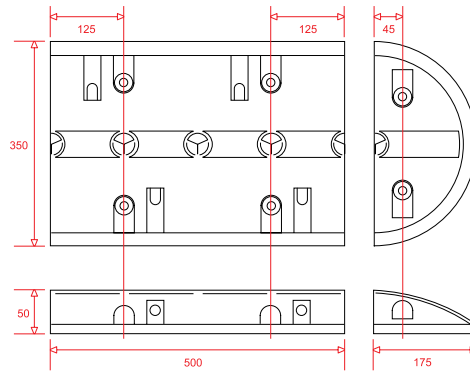

A tough and economic ramp system manufactured from recycled thermoplastic. 50mm high by 500mm wide sold in pairs (one black, one yellow) each pair forms 1 metre in length. Each pair comes complete with sufficient fixings.

- Tough and durable
- 10 mph control rating
- CATS EYES fitted as standard
- Any length of ramp can be formed
- Quickly installed and re-locatable
- Fixing bolts included with all ramp sections (specify type of round)
- Two end sections can also make a circular speed bump

Two end sections make a circular bump!



ECORAMP4
Each section 500mm long.
Sold in pairs
1 Yellow and 1 Black



ECORAMP3
Each section 175mm long.
Sold in pairs
1 Yellow and 1 Black



Premier Speed Ramps



VER1 (sold in pairs)
Highly reflective verge posts, ideal for restricting access, marking obstructions and direction of traffic. 1100mm high comes complete with a 360mm ground spike.

This versatile modular system enables ramps of any length to be formed. Supplied in pairs, one black, one yellow complete with fixings. Each single module is 400mm x 250mm. Ensures speed around sites is controlled and safe. Round endcaps are recommended for a neat finish (supplied in pairs - black). Avoid the expense of on-site accidents.

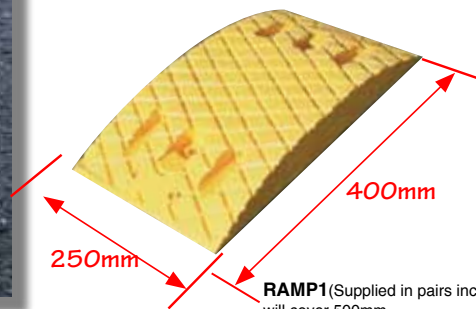

RAMP1 (Supplied in pairs inc. fixings) will cover 500mm.

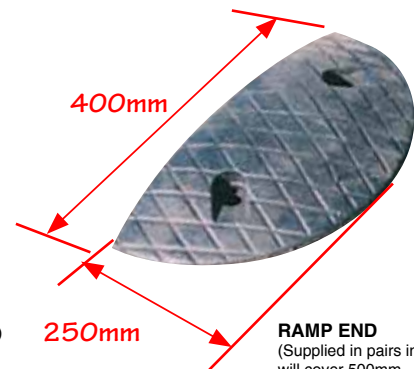

RAMP END (Supplied in pairs inc. fixings) will cover 500mm.

Rubber Cable Protector

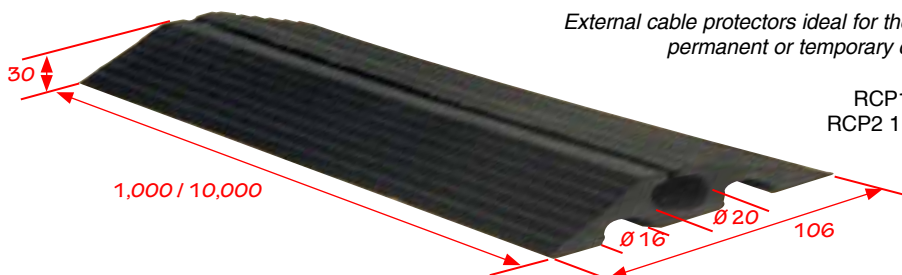

External cable protectors ideal for the protection of permanent or temporary cables on site.

RCP1 10 metre roll
RCP2 1 metre section

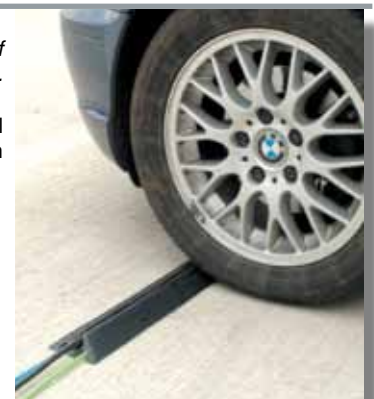

- 3 division cable protector
- Suitable for foot or road traffic
- Time saver 'snap in' of the top cable
- 20mm diameter top hole
- Supplied in 10m rolls or 1m lengths
- Unique 'anti crush' simple to use product

Vehicle Warning



Transport products available as 1mm aluminium or self adhesive vinyl, class 1 reflective.



TRA8S 1260 x 220 Self adhesive vinyl **TRA8R** 1260 x 220 1mm Aluminium



TRA9S 1400 x 140 Self adhesive vinyl **TRA9R** 1400 x 140 1mm Aluminium



TRA10S 700 x 140 (supplied as pair) Self adhesive vinyl



TRA10R 700 x 140 (supplied as pair) 1mm Aluminium



TRA12 S
non-reflective
Self adhesive vinyl
TRA12 R
1mm Aluminium



TRA15S
520 x 250
Self adhesive vinyl
TRA15R
520 x 250
1mm Aluminium



TRA16
200 x 200
TRA17
400 x 400
Self adhesive,
printed in reverse
for easy application
to inside of
windscreen.



WA75A 600 x 100 Self adhesive vinyl



WA75B 600 x 100 Self adhesive vinyl

UN Placards

The labels shown opposite are an (IMDG) requirement on Road, Rail, Tank and Freight vehicles. They allow space for the UN number to be added as required. (Numbers supplied at additional cost).



DA52 250 x 250



DA53 250 x 250



DA54 250 x 250



DA55 250 x 250



DA56 250 x 250



DA57 250 x 250



DA58 250 x 250



DA59 250 x 250



DA60 250 x 250



DA61 250 x 250



DA62 250 x 250



DA63 250 x 250

Hazchem Panels

Hazchem panels available in two materials, 1mm aluminium and self adhesive vinyl. Choose the panel of your choice and we will manufacture complete with your specific UN. number, hazard diamond, code and telephone number. For quantities of 20 or more we will print your logo free of charge in one colour.

HAZCHEM TANKER PLATE



HZ1 700 x 400
Supplied with or without frame holder.



HZ1A
Frame Holder
700 x 400

LOW/NON HAZARDOUS TANKER PLATE

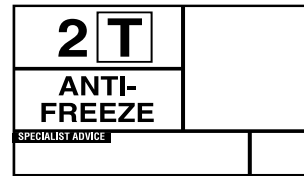

HZ2 700 x 400
Supplied with or without frame holder

VEHICLE WARNING PLATE



HZ3 400 x 300
Supplied with or without frame holder.



HZ3A
Frame Holder
400 x 300

STORAGE INDICATOR PLATE



HZ4 500mm x 300mm

MIXED HAZARD PLATE



HZ5 600mm x 200mm

SITE LOCATION PLATE



HZ6 600mm x 200mm

Low index traffic and caution cones, ideal for hazard avoidance and for warning of potential dangers.



CO1 460mm
Ensure traffic hazards are noticed through using these temporary Hi-visibility traffic cones.



CO2 495mm
Help prevent slips, trips and falls by warning of potential hazards with these, easily stored, cleaning cones.



CO2A 495mm
Help prevent slips, trips and falls by warning of potential hazards with these, easily stored, cleaning cones.



CO2B 510mm
High-visibility No parking cones.



CO1A with text 510mm
Plain cone to accept factory applied message of your choice on each of the 3 sides
CO1B blank 510mm



BCP3 750mm
This cone is made to accept a cone converter, which allows planks to be inserted to form a barrier system.

Mirrors & Barriers



SPP2 610mm high
Hinged parking post, with integral key operating system.



CONBAR2 1000 x 1900mm
Non-reflective concertina barriers offer a quick and easy solution for restricting access around site. Folding for easy storage.



MIR1 620mm
MIR1A 450mm
MIR2 620mm Polycarbonate
MIR2A 450mm Polycarbonate
MIR3 450mm Extension arm



MIR4 600 x 450mm Acrylic
Request as post or wall fix on all mirrors

Information Centres

Magnetic information centres, take your message direct to the factory floor.

Available in any background colour, each centre comes complete with A4 and A3 clear magnetic wallets with matching printed borders.



INFO1 1220 X 915

Includes 10 A4 wallets (single colour of your choice)

INFO2 2440 x 1220

Includes 10 A4 and 6 A3 wallets (single colour of your choice)

Rigid perspex pockets enables instant updating of new information. Supplied complete with magnetic edges ensuring documents are not lost, blown off, or removed.

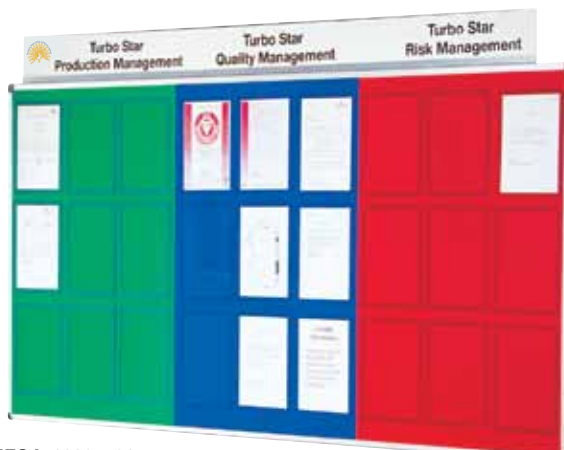

INFO4 1220 x 915

(Up to 3 background colours of your choice)

Includes 10 A4 wallets (3 colours of your choice)

INFO5 2440 x 1220

Includes 10 A4 and 6 A3 wallets (3 colours of your choice).

Each board comes complete with the title header of your choice.

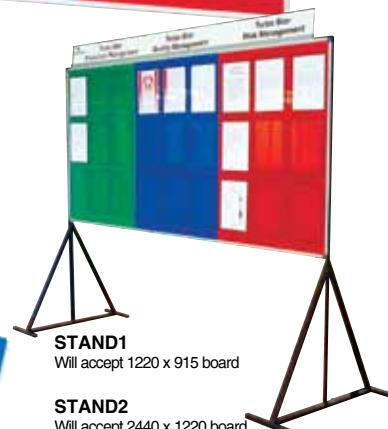

STAND1

Will accept 1220 x 915 board

STAND2

Will accept 2440 x 1220 board (as shown)

PACK1

Contains 10 A4 wallets (Colour of your choice)

PACK2

Contains 10 A4 wallets and 6 A3 wallets (Colour of your choice)

Specialist Dry-wipe Boards

Produced using the latest scanning and graphics technology and applied directly to magnetic or non-magnetic dry-wipe boards.

Machine layouts or production scheduling, keep track of statistics, dates, down time, shift changes etc.

Any diagram can be included. Choose normal dry wipe or magnetic dry wipe. Any size of pockets or holders can be applied to the board of your choice for document storage.

Now more than ever safety awareness is crucial. Use your dry wipe boards, to control, record, advise, staff and visitors of your safety record.

Remember visual impact is three times more effective than verbal communication!

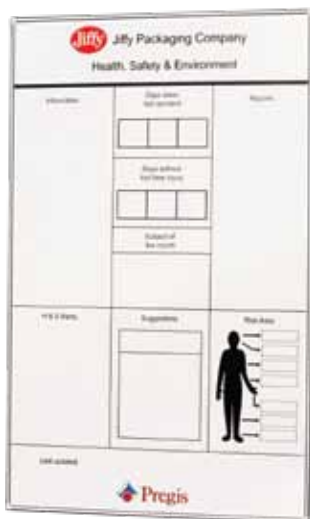

SDW1 Non-magnetic

SDW2 Magnetic

900 x 1220 (complete with graphics)



SDW3 Non-magnetic

SDW4 Magnetic

600 x 900 (complete with graphics)

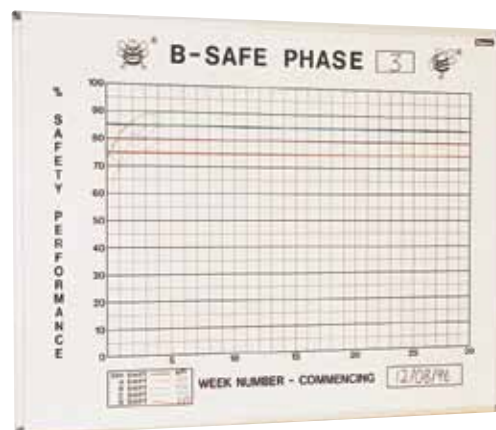

SDW5 Non-magnetic

SDW6 Magnetic

1800 x 1200 (complete with graphics)

Dry-wipe Boards

Magnetic or non-magnetic dry-wipe boards are ideal for training, production or presenting. These versatile boards are supplied complete with aluminium frame, corner caps, wall fixings and tray. Order as blank for general use or we can apply graphics, logos and text to your exact designs.

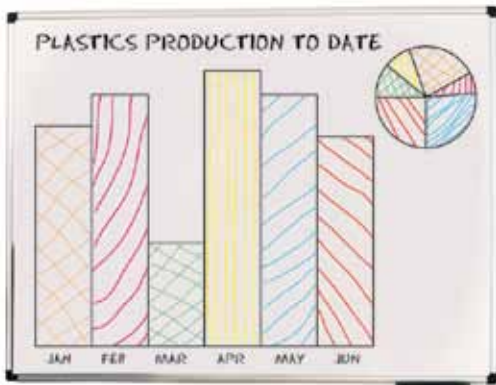

NDW1 600 x 900
NDW2 1200 x 900*

NDW3 1800 x 1200
NDW4 2400 x 1200

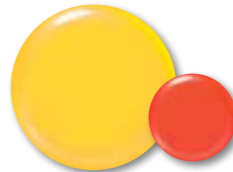

BUT1A 15mm (10 per pack)

BUT2A 30mm (10 per pack)

Magnetic discs use in conjunction with magnetic dry-wipe boards.
Mix of the following colours:
Blue, green, yellow, red, black.



MAG1 600 x 900
MAG2 1200 x 900*

MAG3 1800 x 1200
MAG4 2400 x 1200

*Available with mobile stand as optional extra.

Plain dry-wipe board supplied complete with pen tray, corner caps and all fixings.

Plain magnetic dry-wipe board will accept all types of magnetic products in addition to conventional dry wipe marker pen.

Noticeboards

Classic, aluminium framed, deep pin board, supplied complete with corner caps, and wall fixings.
Fabric Colours available: RED, GREY and BLUE. (Please state colour of fabric when ordering)



PIN1 600 x 900



PIN2 1200 x 900

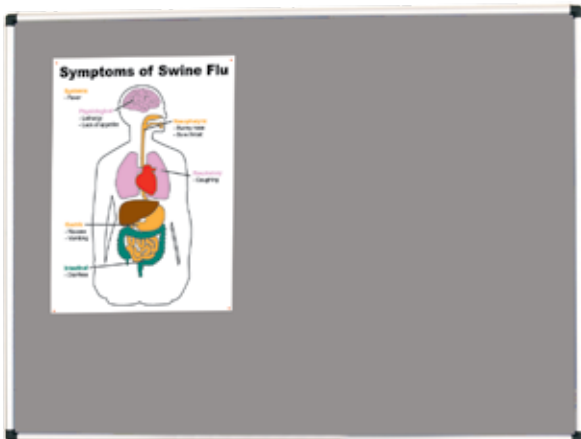

PIN3 1800 x 1200
PIN4 2400 x 1200

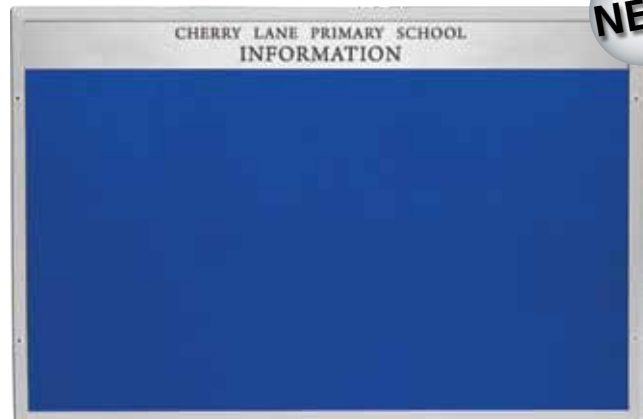

Personalise your pin board with the header of your choice.
Please state required text.

Banner Stands



ARTWORK GUIDELINES

Banner stands are suitable for a range of environments, from retail point of sale to exhibition displays.

Graphics for these systems can be printed on a range of materials, such as, a PVC with light stop backing & anti-scratch finish, paper with a matt over laminate.

Other materials are available upon request.

ARTWORK GUIDELINES

We can accept artwork on CD or DVD in EPS, TIFF or JPEG format.

All artwork must be supplied to 25% of the finished size with a resolution of no less than 300dpi.

All fonts and images used in the design need to be supplied.



BAN20
1600 x 600mm
Lightweight folding banner ideal for short-term marketing campaigns. Complete with carry bag and graphics



BAN22
800 x 2000mm
Lightweight roll-up banner. The stand has a slider system which enables the change of graphics. Comes complete with carry bag and graphics of your choice.



BAN24
800 x 2000mm
Deluxe pull-up banner, single sided. Easily interchangeable. Comes complete with carry bag and graphics of your choice.

BAN26
800 x 2000mm
Deluxe double-sided banner. Comes complete with carry bag and graphics of your choice.

A		
A Boards	71	
Accessories	88-89	
Accident Book	86	
Action Centres	49	
Aisle Markers	88	
Anti-Slip Floor Tape	97	
Armbands (Hi-vis)	27	
Asbestos Management & Logbook	69	
Asbestos Poster	69	
Assembly Point Signs	10	
Abrasive Wheels	74	
Atermis Signs	51	
Alphacurve	52-53	
Arcline	54	
B		
Banners	41, 110	
Banner Stands	110	
Barrier Tapes	96	
Bondings & Fixings	88	
Braille Signs	46	
British Standard Fire Exits	4	
Budget Safety Signs	39	
C		
Cable Protector (Road)	105	
Contravision	45	
Catering Signs	32-33, 91	
CCTV Signs	27	
CD ROMS	87	
CDM Poster	74	
Ceiling Fixings	88	
Cleaners & Degreasers	88	
Chains & Hooks	88-90	
Cleaning Cones	107	
Cleaning Stands	91	
Clearview Prestige Signs	58-61	
Cones	107	
Confined Space Signs	34	
Construction Signs	38-43, 68	
Correx Signs	39	
Coshh Centre	49	
Coshh & Laboratory Tapes	93	
Coshh Posters	75	
Coshh Signs	35	
Cristallo	57	
Custom Braille Signs	47	
Custom Made Site Safety Boards	68	
D		
Design Your Sign	66	
Degreasers & Cleaners	88	
Desktop Signs	55	
Digital Signs	73	
Directory Signs	53	
Display Holders	88	
Door Sliders	50	
Door Signs	50	
Double Sided Signs	53	
Double Sided Fire Exit hanging signs	6	
Dry-wipe Boards	108-109	
E		
EC Fire Exit Signs	7	
Emergency Lighting	9	
External Banner Systems	41, 111	
External Showcases	71-73	
F		
Factory Notices	74	
Fire Action Centre	14	
Fire Action Notices	12	
Fire Door Signs	13	
Fire Equipment Signs	14-15	
Fire Exit Signs	4-9	
Fire Extinguisher Signs	14	
Fire Labels on a roll	13-14	
Fire Log book	15	
Fire Marshal Armband	27	
Fire Projecting Signs	14	
Fire Risk Assessment CD ROM	87	
Fire Training CD ROM	87	
First Aid Armband	27	
First Aid Centre	49	
First Aid Posters	75-85	
First Aid Signs	11	
Fixings	88-89	
Floor Marking	97	
Floor Marking Tape	97	
Floor Signs	36	
Frames (Suspended & Projecting)	88	
Frames (Temporary road traffic)	104	
Frames & Posts	89, 90-91	
Fristem Display	56	
Freestanding	53	
G		
Gel Dispenser	33	
Gel Station Signs	33	
General Information Signs	48, 59, 61	
Glass Awareness Signs	59	
Glow in the Dark Signs	62-65	
Glow in the Dark Tapes	97	
Gun (& Mastic)	88	
H		
Hazard Labels	92-93	
Hazard Signs	22, 27	
Hazard Symbols on a roll	86	
Hazchem Panels	106	
Hazchem & Transport Labels	106	
Health & Safety CD ROM	87	
Health & Safety Law Poster	86	
Hi-vis Armbands	27	
Hotwork Policy & Procedures	86	
HTM 65 Signs	5, 63	
Hygiene Signs	32	
I		
Illuminated Signs	9	
Information Centres	49	
Information Posters	74-86	
Information Signs (General)	45, 48, 58, 61	
Infodoor Signs	61	
Inspection Tapes	94	
Interchangeable Signs	50-58	
L		
Labels on a roll	93-96	
Labels & Tapes	93-96	
Locking Poster Frames	70-71	
Lollipop	101	
Log Books	86	
Luminaries	9	
M		
Making Sense of Safety Posters	79	
Mandatory Signs	28-33	
Mastic (& Handheld Gun)	88	
Mirrors	107	
Multi-Purpose Signs	34-35	
N		
Notice Boards	72-73, 108-109	
O		
One Point Safety Posters	78	
P		
Parking Posts	107	
Parking & Site Management Signs	101-103	
Primer Kit	88	
Photoluminescent Floor Marking Tapes	89	
Photoluminescent Signs	62-65	
Pin Boards	109	
Pipe ID Tapes & Labels	98-99	
Posters	70-85	
Poster Frames	70-72	
Posts & Fixings	89-90, 104	
Prestige Signs	60	
Prohibition Signs	16-21	
Projecting Frames	88	
Projecting Signs	5, 11, 14	
Q		
Quality Tapes	94	
R		
Recycling Signs	42-43	
Refuge Guidance Signs	6	
Road Cables Protectors	105	
Road Speed Ramps	105	
S		
Safe Condition Signs	4-11	
Safety Labels	44	
Safety Lights	9	
Safety Posters	74-85	
Safety Signs, Posts & Chains	90	
Scaffold Signs	42	
Seatbelt Signs	29	
Security CD ROM	87	
Security Signs	27	
Security Tapes	96	
Sign Surface Preparation Kit	88	
Site Safety Banners	41	
Site Safety Signs	38-40	
Simpson Posters	84	
Speed Ramps	105	
Stop/Go Lollipop	101	
Stanchions	104	
Street Signs	103	
Suspending & Projecting Frames	88	
Suspension Sign Frames	88	
T		
Tabletop Signs	55	
Tapes & Labels	92-99	
Temporary Traffic Signs	102-103	
Traffic Cones	107	
Traffic Mirrors	107	
Traffic Posts	104	
Traffic Ramps	105	
Traffic Signs	100-103	
Training CD ROMS	87	
Transport & Hazchem Labels	92-93	
Tuff Signs	40	
Tye Tags	21	
U		
Underground Tapes	96	
UN Placards	93	
V		
Vehicle Hazard Signs	106	
Verge Posts	105	
VDU Welfare Training CD ROM	87	
W		
Wall Fixings	88	
What you should know posters	75	
Window Fixings	88	
Window Signs	45, 53	
Workplace Risk Assessment CD ROM	87	
Workstation Welfare CD ROM	87	